



# CHB300W-110S CMFC(D) SERIES 198-300 WATT 4:1 INPUT ISOLATED DC-DC CONVERTERS

## Features

- Efficiency to 90.5%
- Fixed Switching Frequency
- Regulated Outputs
- Remote On/Off
- Low No Load Power Consumption
- Fully Protected (OTP/OCV/OVP/UVLO)
- 3000Vdc I/O Isolation
- Operating Case Temperature -40 to +100°C
- UL 60950-1 2<sup>nd</sup> (Basic Insulation) Approval for DC Modules (Except 3.3Vout)
- EN 50155 for EMC, Environmental and Characteristic
- Shock & Vibration EN 50155 (EN 61373) Compliant
- Fire & Smoke EN 45545-2 Compliant
- Safety Meets IEC/EN/UL 62368-1
- Build-In EMI Filter
- Chassis Mount, Baseplate Cooled



MODEL NUMBER	INPUT VOLTAGE	OUTPUT VOLTAGE	OUTPUT CURRENT		INPUT CURRENT		% EFF.	CAPACITOR LOAD MAX.
			MIN.	MAX.	NO LOAD	FULL LOAD		
CHB300W-110S3V3□-CMFC CHB300W-110S3V3□-CMFD	43-160 VDC	3.3 VDC	0 mA	60.0A	15 mA	2117 mA	85	60000uF
CHB300W-110S05□-CMFC CHB300W-110S05□-CMFD	43-160 VDC	5 VDC	0 mA	60.0A	15 mA	3153 mA	86.5	60000uF
CHB300W-110S12□-CMFC CHB300W-110S12□-CMFD	43-160 VDC	12 VDC	0 mA	25.0A	15 mA	3047 mA	89.5	25000uF
CHB300W-110S24□-CMFC CHB300W-110S24□-CMFD	43-160 VDC	24 VDC	0 mA	12.5A	15 mA	3064 mA	89	12500uF
CHB300W-110S28□-CMFC CHB300W-110S28□-CMFD	43-160 VDC	28 VDC	0 mA	10.7A	15 mA	3060 mA	89	10700uF
CHB300W-110S48□-CMFC CHB300W-110S48□-CMFD	43-160 VDC	48 VDC	0 mA	6.25A	15 mA	3013 mA	90.5	4700uF

NOTE:

1. Nominal Input Voltage 110VDC
2. □ = N or None
3. VR1 is used for Output Voltage Adjustment.
4. Refer to application note for thermal resistance and derating information.
5. TVS is included for input surge voltage protection.
6. Recommend an external fuse for input reverse polarity protection (shunt diode is included inside).

## PART NUMBER

Series	Nominal Input Voltage	Number of Outputs	Nominal Output Voltage	Remote On/Off Logic	Chassis Mount Type		Heatsink
					-YYY	Z	
CHB300W-	III	O	XX	L	-YYY	Z	+VWW
CHB300W	110 : 110 VDC	S : Single	3V3 : 3.3VDC 05 : 5.0VDC 12 : 12VDC 24 : 24VDC 28 : 28VDC 48 : 48VDC	None : Positive N : Negative	Chassis Mount Built in Filter	C : Open Frame D : With Cover	None : Blank HS : Heatsink HD : Heatsink+Din Rail

Part Number Example:

**CHB300W-110S12N-CMFC:** Chassis Mount, 300W, 4:1 43-160Vdc Input, Single 12Vdc Output, Negative Logic, Open Frame



# CHB300W-110S CMFC(D) Series

## TECHNICAL SPECIFICATIONS

(All specifications are typical at nominal input, full load at 25°C unless otherwise noted.)

### ABSOLUTE MAXIMUM RATINGS

PARAMETER	NOTES and CONDITIONS	Device	Min.	Typ.	Max.	Units
Input Voltage	Continuous	All	-0.3		160	V <sub>dc</sub>
Input Surge Voltage	100ms max.	All			200	V <sub>dc</sub>
Operating Case Temperature	At the center part of base plate	All	-40		100	°C
Storage Temperature		All	-40		105	°C

### INPUT CHARACTERISTICS

PARAMETER	NOTES and CONDITIONS	Device	Min.	Typ.	Max.	Units	
Operating Input Voltage		All	43	110	160	V <sub>dc</sub>	
Input Under Voltage Lockout							
Turn-On Voltage Threshold	Full load	All	40	42	43	V <sub>dc</sub>	
Turn-Off Voltage Threshold	Full load	All	37.5	39.5	40.5	V <sub>dc</sub>	
Lockout Hysteresis Voltage	Full load	All		2.5		V <sub>dc</sub>	
Maximum Input Current	V <sub>in</sub> =43V, Full load	All		9		A	
No-Load Input Current	V <sub>in</sub> =110V, I <sub>o</sub> =0A	See Model Number Table					mA

### OUTPUT CHARACTERISTICS

PARAMETER	NOTES and CONDITIONS	Device	Min.	Typ.	Max.	Units
Voltage Set Point Accuracy	V <sub>in</sub> =110V, Full load, T <sub>c</sub> =25°C	All	-1.0		+1.0	%
Output Voltage Regulation						
Load Regulation	Full load to no load	3.3&5.0V Others			±0.5 ±0.2	%
Line Regulation	V <sub>in</sub> =High line to low line, full load	All			±0.2	%
Temperature Coefficient	T <sub>c</sub> =-40°C to 100°C	All			±0.02	%/°C
Output Voltage Ripple and Noise (5Hz to 20MHz Bandwidth)						
Peak-to-Peak	Full load, 1uF ceramic capacitor	3.3Vo			120	mV
		5.0Vo			120	
		12Vo			150	
		24Vo			200	
		28Vo			200	
		48Vo			300	
RMS.	Full load, 1uF ceramic capacitor	3.3Vo			60	mV
		5.0Vo			60	
		12Vo			80	
		24Vo			100	
		28Vo			100	
		48Vo			150	
Output Current Range	V <sub>in</sub> = 43 to 160V	See Model Number Table				A
Over Current Protection	Hiccup mode. Auto recovery.	All	110	125	160	%
Over Voltage Protection	Limited voltage, % of nominal V <sub>o</sub>	All	115	125	140	%
Short Circuit Protection		All	Continuous, Auto Recovery			
External Load Capacitance	Full load (resistive)	See Model Number Table				uF
Output Voltage Trim Range	P <sub>o</sub> ≤ max. rated power, I <sub>o</sub> ≤ I <sub>o_max</sub> .	All	-10		+10	%
Output Voltage Remote Sense Range	P <sub>o</sub> ≤ max. rated power, I <sub>o</sub> ≤ I <sub>o_max</sub> . % of nominal V <sub>o</sub>	All			+10	%



# CHB300W-110S CMFC(D) Series

## EFFICIENCY

PARAMETER	NOTES and CONDITIONS	Device	Min.	Typ.	Max.	Units
100% Load	$V_{in}=110V$	See Model Number Table				%

## DYNAMIC CHARACTERISTICS

PARAMETER	NOTES and CONDITIONS	Device	Min.	Typ.	Max.	Units
Output Voltage Current Transient						
Error Band	75% to 100% of $I_{o\_max}$ . step load change $di/dt=0.1A/us$ (within 1% $V_{out}$ nominal)	All			±5	%
Recovery Time		All			250	us
Turn-On Delay and Rise Time						
Full load (Constant resistive load)						
Turn-On Delay Time, From On/Off Control	$V_{on/off}$ to 10% $V_{o\_set}$ , Remote on	All		30		ms
Turn-On Delay Time, From Input	$V_{in\_min.}$ to 10% $V_{o\_set}$ , Power up	All		30		ms
Output Voltage Rise Time	10% $V_{o\_set}$ to 90% $V_{o\_set}$	All		20		ms

## ISOLATION CHARACTERISTICS

PARAMETER	NOTES and CONDITIONS	Device	Min.	Typ.	Max.	Units
Isolation Voltage (100% factory Hi-Pot tested @2sec.)	1 Minute; input to output	All			3000	$V_{dc}$
	1 Minute; input to case (base plate)				3000	$V_{dc}$
	1 Minute; output to case (base plate)				500	$V_{ac}$
Isolation Resistance	Input to output	All	100			MΩ
Isolation Capacitance	Input to output	All		8000		pF
	Input to case (base plate)			11000		
	Output to case (base plate)			22000		

## FEATURE CHARACTERISTICS

PARAMETER	NOTES and CONDITIONS	Device	Min.	Typ.	Max.	Units
Switching Frequency	Pulse width modulation (PWM), fixed	3.3Vo Others	225 270	250 300	275 330	KHz
On/Off Control, Positive Remote On/Off Logic, Refer to -Vin Pin						
Logic Low (Module Off)	$V_{on/off}$ at $I_{on/off}=1.0mA$	All	0		1.2	V
Logic High (Module On)	$V_{on/off}$ at $I_{on/off}=0.0uA$ , Pin open=on	All	3.5		160	V
On/Off Control, Negative Remote On/Off Logic, Refer to -Vin Pin						
Logic High (Module Off)	$V_{on/off}$ at $I_{on/off}=0.0uA$ , Pin open=off	All	3.5		160	V
Logic Low (Module On)	$V_{on/off}$ at $I_{on/off}=1.0mA$	All	0		1.2	V
On/Off Current (for Both Remote On/Off Logic)	$I_{on/off}$ at $V_{on/off}=0V$	All		0.3	1	mA
Leakage Current (for Both Remote On/Off Logic)	Logic high, $V_{on/off}=15V$	All			30	uA
Off Converter Input Current	Shutdown input idle current	All		5	10	mA
Over Temperature Shutdown	Temperature at the center part of base plate, non-latching	All		110		°C
Over Temperature Recovery		All		100		°C

## GENERAL SPECIFICATIONS

PARAMETER	NOTES and CONDITIONS	Device	Min.	Typ.	Max.	Units
MTBF	$I_o=100%$ of $I_{o\_max.}$ ; MIL-HDBK - 217F_Notice 1, GB, 25°C	3.3Vo		515		K hours
		5.0Vo		415		
		12Vo		454		
		24Vo		496		
		28Vo		462		
		48Vo		627		



# CHB300W-110S CMFC(D) Series

PARAMETER	NOTES and CONDITIONS	Device	Min.	Typ.	Max.	Units
Weight		-CMFC -CMFD -CMFD+HS -CMFD+HD		380 435 877 899		grams
Base Plate Material	Aluminum					
Potting Material	UL 94V-0 (DC Module)					
Shock/Vibration	EN 50155 (EN 61373) Compliant					
Humidity	95% RH max. Non condensing					
Altitude	5000m Operating altitude, 12000m Transport altitude					
Thermal Shock	MIL-STD-810F					
Fire & Smoke	EN 45545-2 Compliant					
EMI	EN 50155 Compliant (with external output filter)				Class A	
ESD	EN 61000-4-2	Level 3: Air $\pm 8$ kV, Contact $\pm 6$ kV			Perf. Criteria A	
Radiated Immunity	EN 61000-4-3	Level 3: 80~1000MHz, 20V/m			Perf. Criteria A	
Fast Transient	EN 61000-4-4	Level 3: On power input port, $\pm 2$ kV			Perf. Criteria A	
Surge	EN 61000-4-5	Level 4: Line to earth, $\pm 4$ kV, Line to line, $\pm 2$ kV			Perf. Criteria A	
Conducted Immunity	EN 61000-4-6	Level 3: 0.15~80MHz, 10V			Perf. Criteria A	
Interruptions of Voltage Supply	EN 50155	Class S3: 20ms with external hold up circuit			Perf. Criteria A	
Supply Change Over	EN 50155	Class C2: 30ms with external hold up circuit			Perf. Criteria A	
Application Note Link						<a href="#">CHB300W-110S CMFC(D) Series App Notes</a>
Packaging Information Link						<a href="#">Packaging Information</a>

## Immunity to Environmental Conditions

Phenomenon	EN 50155; 2017 Reference Clause(s)	Reference Standard	Test Conditions	Result
Low Temperature Start-up test	13.4.4	EN 60068-2-1	Class OT6 Temperature: -40°C Duration: 2 hrs	Pass
Dry Heat Test	13.4.5	EN 60068-2-2	Class OT6 & ST0 Temperature: 85°C Duration: 6 hrs	Pass
Low Temperature Storage Test	13.4.6	EN 60068-2-1	Temperature: -40°C Duration: 16 hrs	Pass
Cyclic Damp Heat Test	13.4.7	EN 60068-2-30	Temperature: 25°C - 55°C Humidity: 90% RH Duration: 48 hrs	Pass
Random Vibration Test	13.4.11	EN 61373	Temperature: 25°C +/- 10°C Humidity: 50% +/-25% RH Frequency range: 5 ~ 150 Hz Vertical: 1.01 $m/s^2$ Transverse: 1.01 $m/s^2$ Longitudinal: 1.01 $m/s^2$ Duration: 10 min / axis	Pass
Simulated Long Life Test at Increased Random Vibration Levels	13.4.11	EN 61373	Temperature: 25°C +/-10°C Humidity: 50% +/-25% RH Frequency range: 5 ~ 150 Hz Vertical: 5.72 $m/s^2$ Transverse: 5.72 $m/s^2$ Longitudinal: 5.72 $m/s^2$ Duration: 5 hrs / axis	Pass
Shock Test	13.4.11	EN 61373	Temperature: 25°C +/-10°C Humidity: 50% +/-25% RH Frequency range: 5 ~ 150 Hz +/-Vertical: 50 $m/s^2$ +/-Transverse: 50 $m/s^2$ +/-Longitudinal: 50 $m/s^2$ Duration: 30ms x18 (Each axis 3 shocks)	Pass



# CHB300W-110S CMFC(D) Series

## EN 45545-2 Fire & Smoke Test Conditions

Item		Standard	Hazard Level
R22	Oxygen Index Test	EN 45545-2: 2013+A1:2015 EN ISO 4589-2: 2017	HL1, HL2, HL3
	Smoke Density Test	EN 45545-2: 2013+A1:2015 EN ISO 5659-2: 2017	HL1, HL2, HL3
	Smoke Toxicity Test	EN 45545-2: 2013+A1:2015 NF X70-100-1 and -2: 2006	HL1, HL2, HL3
R23	Oxygen Index Test	EN 45545-2: 2013+A1:2015 EN ISO 4589-2: 2017	HL1, HL2, HL3
	Smoke Density Test	EN 45545-2: 2013+A1:2015 EN ISO 5659-2: 2013	HL1, HL2, HL3
	Smoke Toxicity Test	EN 45545-2: 2013+A1:2015 NF X70-100-1 and -2: 2006	HL1, HL2, HL3
R24	Oxygen Index Test	EN 45545-2: 2013 EN ISO 4589-2	HL1, HL2, HL3
R25	Glow - Wire Test	EN 45545-2+A1:2016 EN 60695-2-11:2014	HL1, HL2, HL3
R26	Vertical Flame Test	EN 45545-2: 2013 EN 60695-11-10: 2013	HL1, HL2, HL3

## CHARACTERISTIC CURVE

### Power Derating Curve

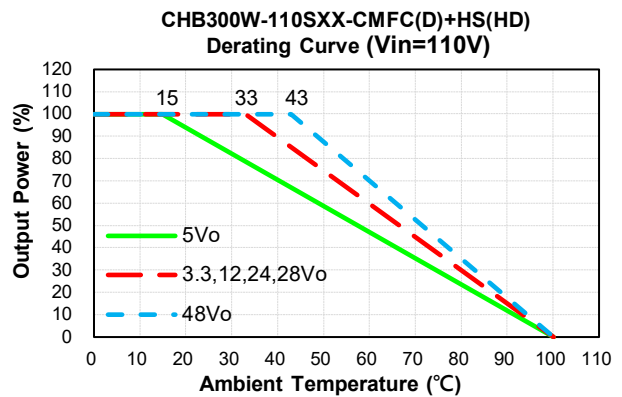
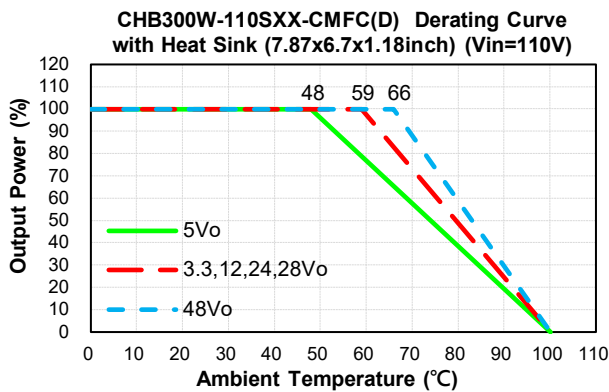

### Performance Data

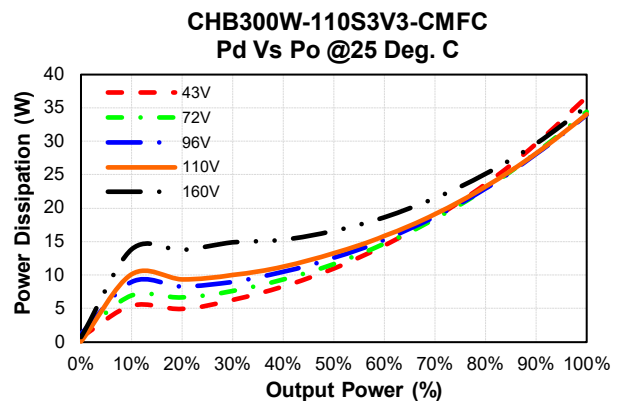
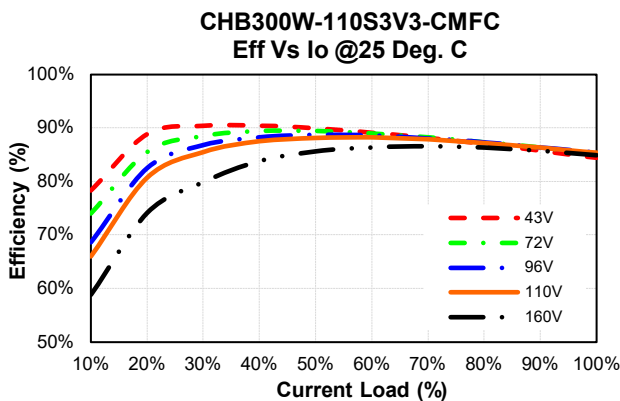



# CHB300W-110S CMFC(D) Series

**CHB300W-110S05-CMFC**  
Eff Vs Io @25 Deg. C

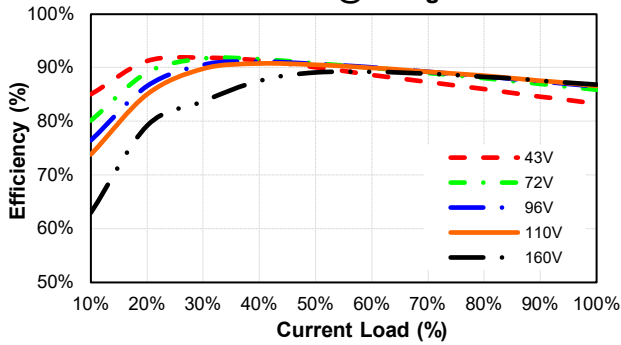

**CHB300W-110S05-CMFC**  
Pd Vs Po @25 Deg. C

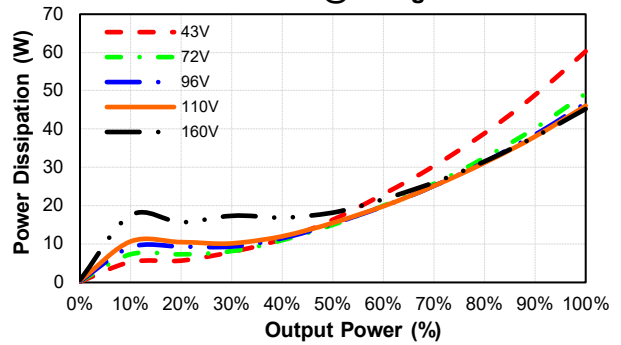

**CHB300W-110S12-CMFC**  
Eff Vs Io @25 Deg. C

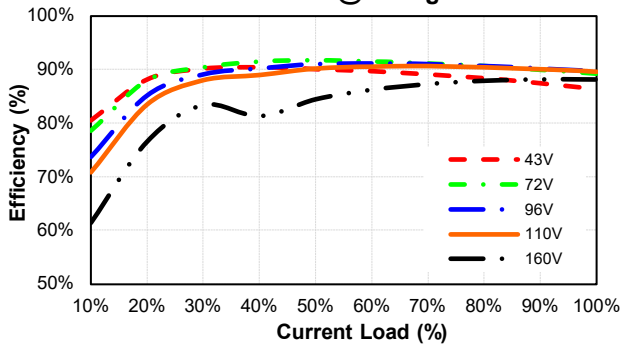

**CHB300W-110S12-CMFC**  
Pd Vs Po @25 Deg. C

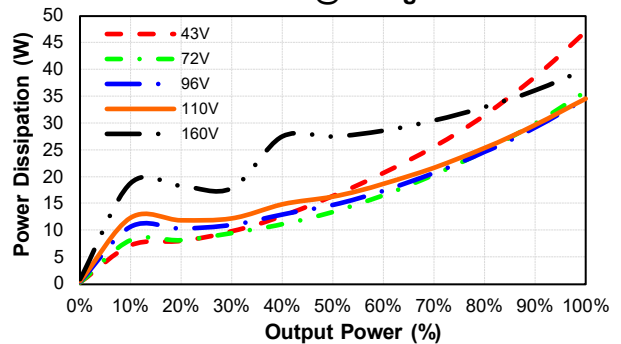

**CHB300W-110S24-CMFC**  
Eff Vs Io @25 Deg. C

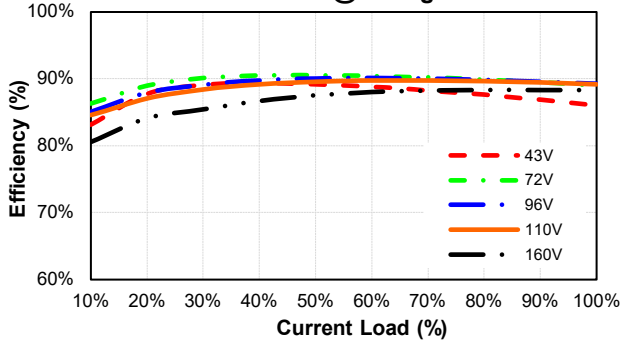

**CHB300W-110S24-CMFC**  
Pd Vs Po @25 Deg. C

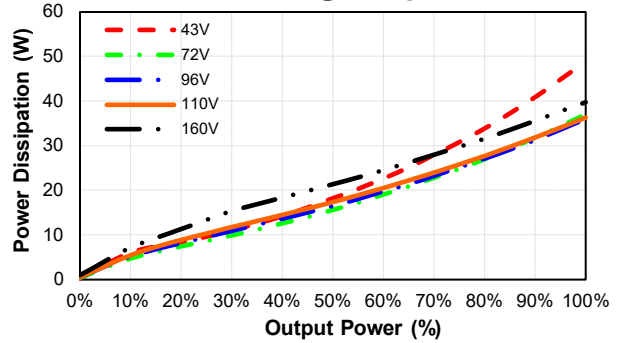

**CHB300W-110S28-CMFC**  
Eff Vs Io @25 Deg. C

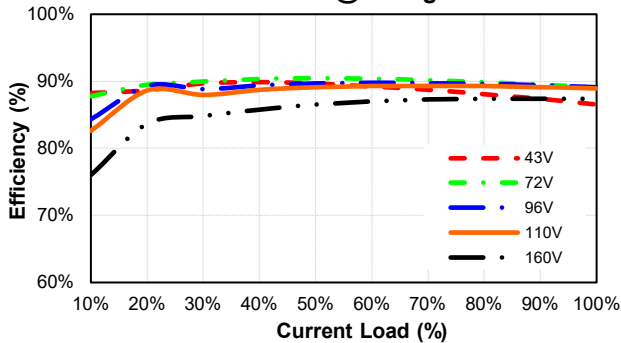

**CHB300W-110S28-CMFC**  
Pd Vs Po @25 Deg. C

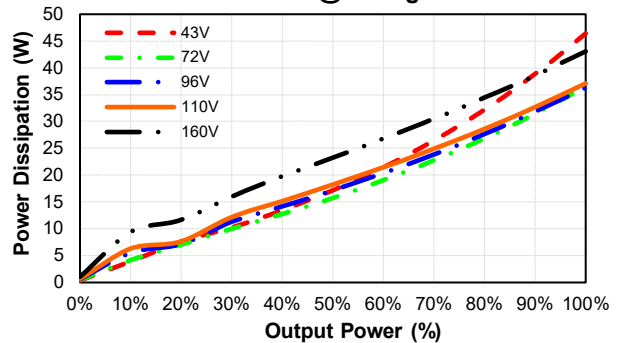



# CHB300W-110S CMFC(D) Series

**CHB300W-110S48-CMFC**  
Eff Vs Io @25 Deg. C

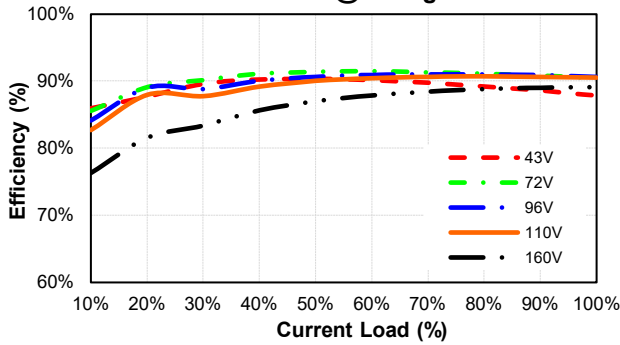

**CHB300W-110S48-CMFC**  
Pd Vs Po @25 Deg. C

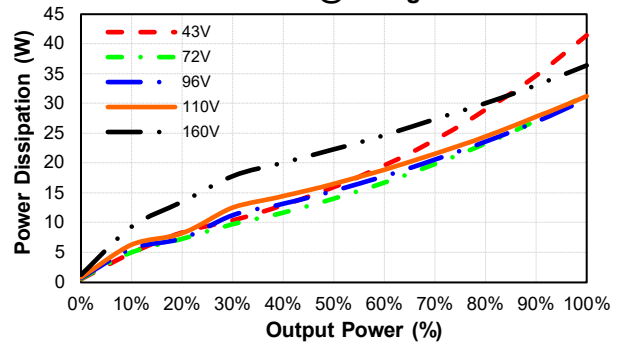

## MECHANICAL SPECIFICATION

CMFC for 3.3&5Vout

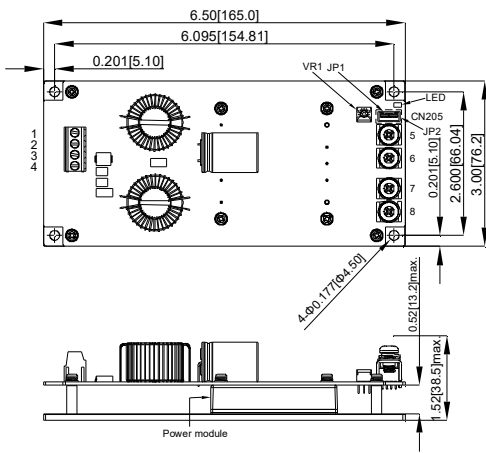

CMFD with Cover for 3.3&5Vout

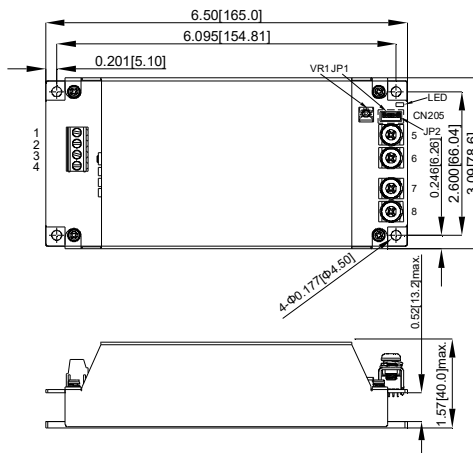

CN205: PIN CONNECTION

Pin	Function
1	+Sense
2	+V Output
3	-Sense
4	-V Output

\*JP1: Short PIN1 & PIN2

\*JP2: Short PIN3 & PIN4

PIN CONNECTION

Pin	Function
1	Case
2	On/Off
3	-V Input
4	+V Input
5	-V Output
6	-V Output
7	+V Output
8	+V Output

All Dimensions In Inches (mm)  
Tolerance Inches: X.XX= ±0.02, X.XXX= ±0.010  
Millimeters: X.X= ±0.5, X.XX= ±0.25

CMFC for Others

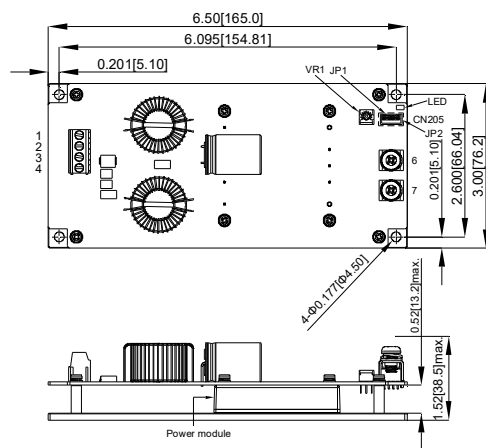

CMFD with Cover for Others

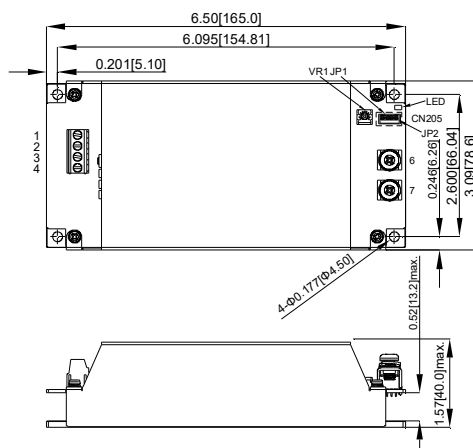

CN205: PIN CONNECTION

Pin	Function
1	+Sense
2	+V Output
3	-Sense
4	-V Output

\*JP1: Short PIN1 & PIN2

\*JP2: Short PIN3 & PIN4

PIN CONNECTION

Pin	Function
1	Case
2	On/Off
3	-V Input
4	+V Input
6	-V Output
7	+V Output

All Dimensions In Inches (mm)  
Tolerance Inches: X.XX= ±0.02, X.XXX= ±0.010  
Millimeters: X.X= ±0.5, X.XX= ±0.25



# CHB300W-110S CMFC(D) Series

## MECHANICAL SPECIFICATION

### CMFD with Cover for 3.3&5Vout +HS

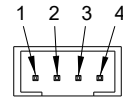
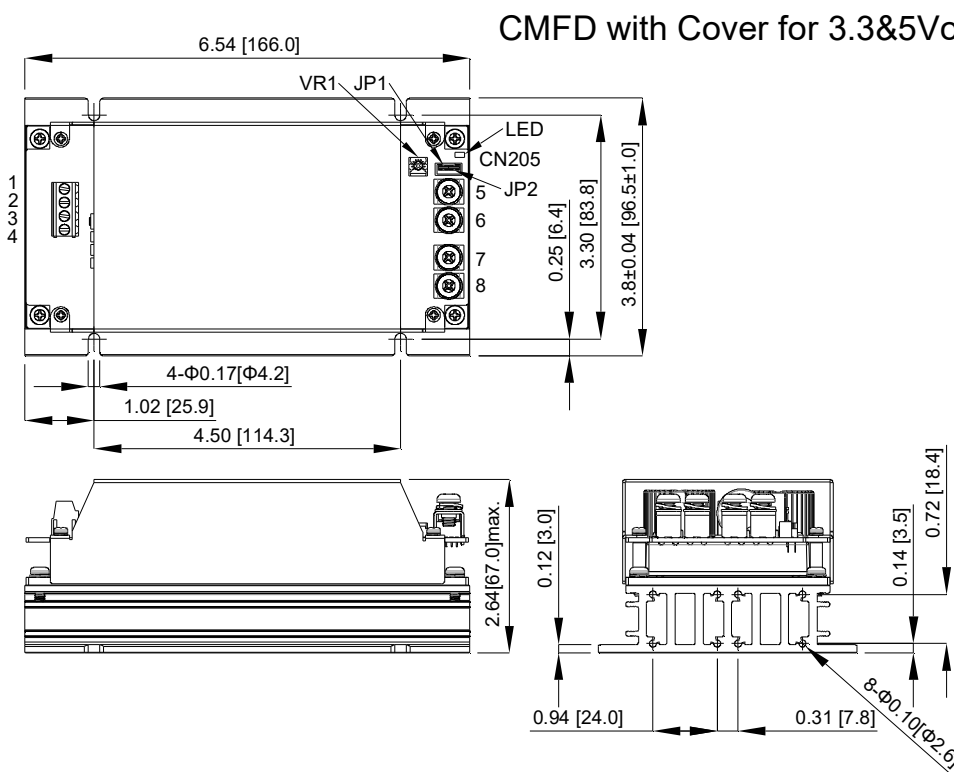

CN205 : PIN CONNECTION

PIN	Function
1	+Sense
2	+V Output
3	-Sense
4	-V Output

\*JP1 : Short PIN1 & PIN2

\*JP2 : Short PIN3 & PIN4

PIN CONNECTION

PIN	Function
1	Case
2	On/Off
3	-V Input
4	+V Input
5	-V Output
6	-V Output
7	+V Output
8	+V Output

All Dimensions in Inches[mm]  
Tolerance Inches: x.xx=±0.02, x.xxx=±0.010  
Millimeters: x.x=±0.5, x.xx=±0.25

### CMFD with Cover for Others +HS

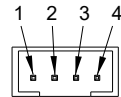
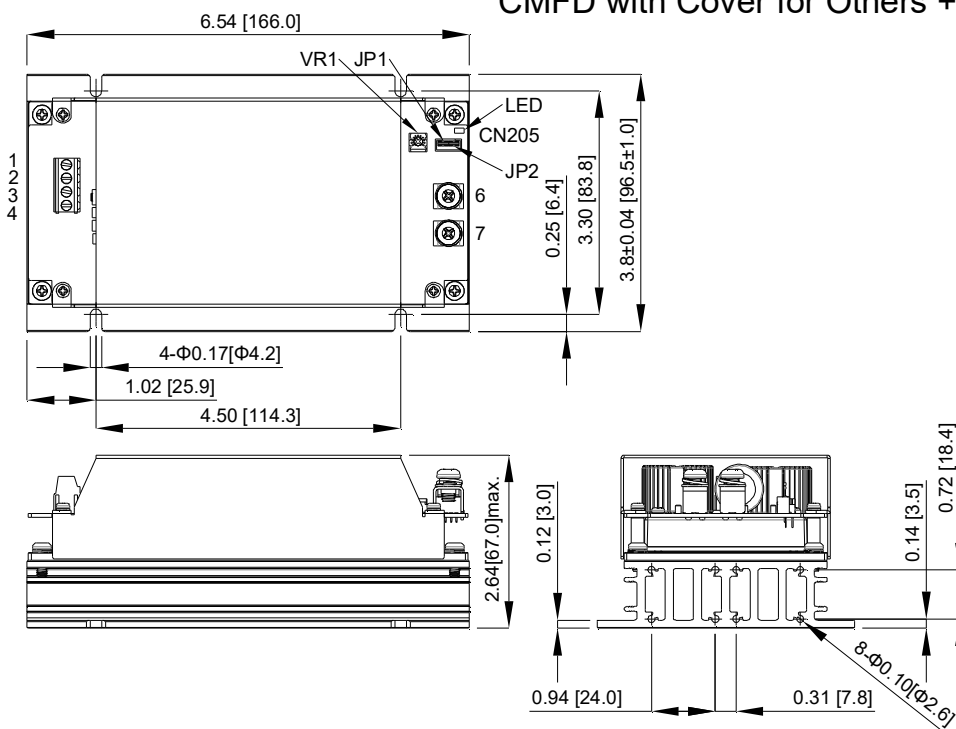

CN205 : PIN CONNECTION

PIN	Function
1	+Sense
2	+V Output
3	-Sense
4	-V Output

\*JP1 : Short PIN1 & PIN2

\*JP2 : Short PIN3 & PIN4

PIN CONNECTION

PIN	Function
1	Case
2	On/Off
3	-V Input
4	+V Input
6	-V Output
7	+V Output

All Dimensions in Inches[mm]  
Tolerance Inches: x.xx=±0.02, x.xxx=±0.010  
Millimeters: x.x=±0.5, x.xx=±0.25





# CHB300W-110S CMFC(D) Series

## MECHANICAL SPECIFICATION

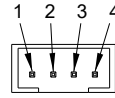
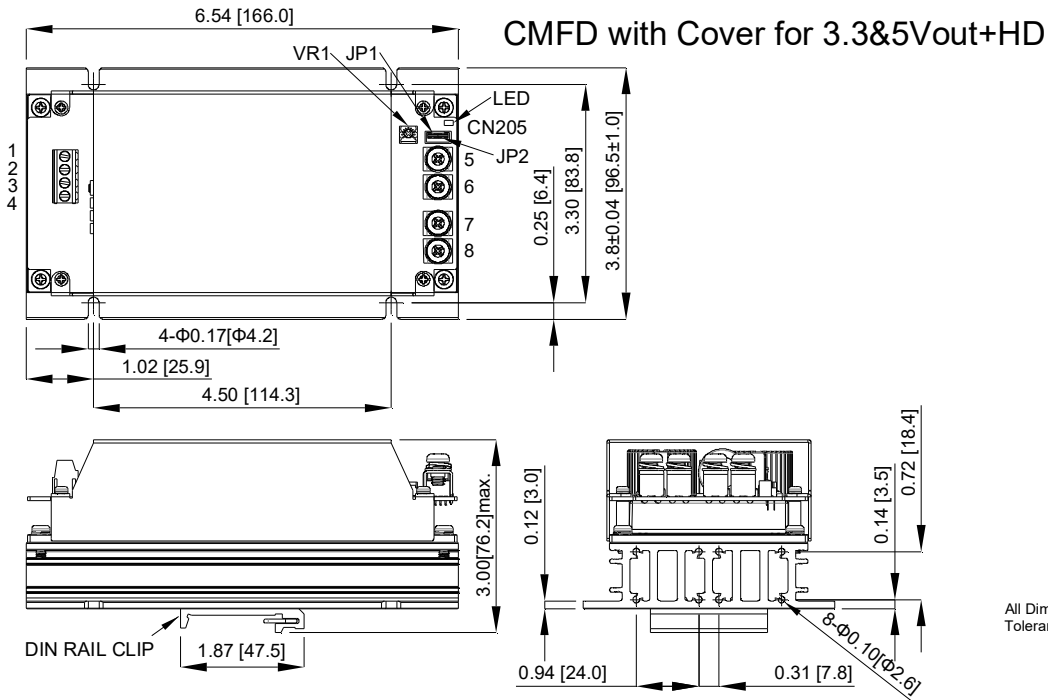

PIN	Function
1	+Sense
2	+V Output
3	-Sense
4	-V Output

\*JP1 : Short PIN1 & PIN2  
\*JP2 : Short PIN3 & PIN4

### PIN CONNECTION

PIN	Function
1	Case
2	On/Off
3	-V Input
4	+V Input
5	-V Output
6	-V Output
7	+V Output
8	+V Output

All Dimensions in Inches[mm]  
Tolerance Inches: x.xx=±0.02, x.xxx=±0.010  
Millimeters: x.x=±0.5, x.xx=±0.25

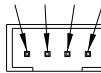
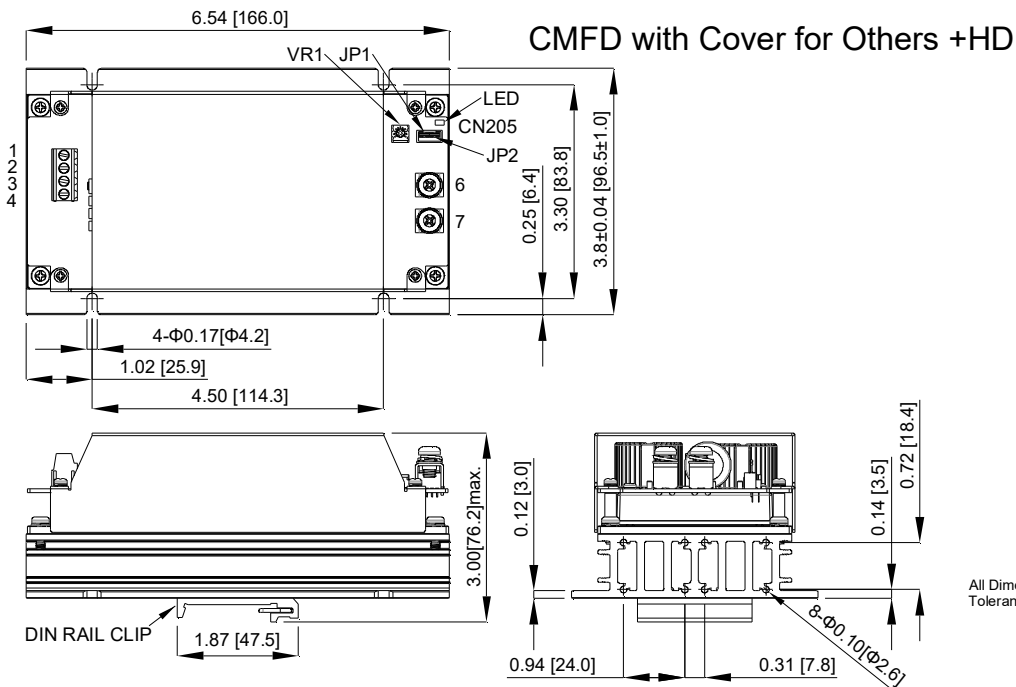

### CN205 : PIN CONNECTION

PIN	Function
1	+Sense
2	+V Output
3	-Sense
4	-V Output

\*JP1 : Short PIN1 & PIN2  
\*JP2 : Short PIN3 & PIN4

### PIN CONNECTION

PIN	Function
1	Case
2	On/Off
3	-V Input
4	+V Input
6	-V Output
7	+V Output

All Dimensions in Inches[mm]  
Tolerance Inches: x.xx=±0.02, x.xxx=±0.010  
Millimeters: x.x=±0.5, x.xx=±0.25