



CQB75-300S-CMFC(D) SERIES

50-75 WATT 2:1 INPUT

ISOLATED DC-DC CONVERTERS

Features

- Efficiency Up to 90%
- Fixed Switching Frequency
- Regulated Outputs
- Remote On/Off
- Low No Load Power Consumption
- Fully protected (OTP/OCP/OVP/UVLO)
- 3000Vac I/O Isolation
- Operating Case Temperature -40 to +100°C
- UL62368-1 (Reinforce Insulation) Approval for DC Modules
- EN55032/22 for EMC Characteristic
- Shock & Vibration Mil-STD-810F Compliant
- Fire & Smoke EN45545-2 Compliant
- Safety Meets IEC/EN/UL 62368-1
- Build-In EMI Filter
- Chassis Mount, Baseplate Cooled



MODEL NUMBER	INPUT VOLTAGE	OUTPUT VOLTAGE	OUTPUT CURRENT		INPUT CURRENT		% EFF.	CAPACITOR LOAD MAX.
			MIN.	MAX.	NO LOAD	FULL LOAD		
CQB75-300S3V3□-CMFC CQB75-300S3V3□-CMFD	180-450 VDC	3.3 VDC	0 mA	15.0 A	10 mA	206 mA	80	15000uF
CQB75-300S05□-CMFC CQB75-300S05□-CMFD	180-450 VDC	5 VDC	0 mA	15.0 A	10 mA	305 mA	82	15000uF
CQB75-300S12□-CMFC CQB75-300S12□-CMFD	180-450 VDC	12 VDC	0 mA	6.25 A	10 mA	284 mA	88	6250uF
CQB75-300S15□-CMFC CQB75-300S15□-CMFD	180-450 VDC	15 VDC	0 mA	5.0 A	10 mA	281 mA	89	5000uF
CQB75-300S24□-CMFC CQB75-300S24□-CMFD	180-450 VDC	24 VDC	0 mA	3.12 A	10 mA	277 mA	90	3300μF
CQB75-300S48□-CMFC CQB75-300S48□-CMFD	180-450 VDC	48 VDC	0 mA	1.56 A	10 mA	281 mA	89	1000μF

NOTE:

1. Nominal Input Voltage 300 VDC
2. □ = N or none
3. VR is Used for Output Voltage Adjustment.
4. Refer to Application Note for Thermal Resistance and Derating Information.
5. TVS is Included for Input Surge Voltage Protection.
6. Recommend an External Fuse for Input Reverse Polarity Protection (shunt diode is included inside).
7. Output connector CN3 wafer with TAIWAN KING PIN TERMINAL P110I series and mate with JST housing PH series or equivalent.
8. CN1 connection: DINKLE 166-04P5 series or equivalent, suitable electric wire: 18~12AWG (IEC 0.5~4mm²).
9. CN2 connection: DINKLE EK500V-04P series or equivalent, suitable electric wire: 24~12AWG (IEC 0.5~2.5mm²).



CQB75-300S CMFC(D) Series

PART NUMBER

Series	Nominal Input Voltage	Number of Outputs	Nominal Output Voltage	Remote On/Off Logic	Chassis Mount Type		Heatsink
CQB75-	II	O	XX	L	-YYY	Z	+WW
CQB75	300 : 300VDC	S : Single	3V3 : 3.3VDC 05 : 5VDC 12 : 12VDC 15 : 15VDC 24 : 24VDC 48 : 48VDC	NONE : Positive N : Negative	Chassis CMF : Mount Built in Filter	C : OpenFrame D : With Cover	None : Blank HS : Heatsink HD : Heatsink+Din Rail

Part Number Example:

CQB75-300S12N-CMFC: Chassis Mount, 75W, 2:1 180-450Vdc Input, Single 12Vdc Output, Negative Logic, Open Frame



CQB75-300S CMFC(D) Series

TECHNICAL SPECIFICATIONS

(All specifications are typical at nominal input, full load at 25°C unless otherwise noted.)

ABSOLUTE MAXIMUM RATINGS

PARAMETER	NOTES and CONDITIONS	Device	Min.	Typ.	Max.	Units
Input Voltage	Continuous	All	-0.3		450	V _{dc}
Input Surge Voltage	100ms max.	All			500	V _{dc}
Operating Case Temperature	At the center part of base plate	All	-40		100	°C
Storage Temperature		All	-40		105	°C

INPUT CHARACTERISTICS

PARAMETER	NOTES and CONDITIONS	Device	Min.	Typ.	Max.	Units
Operating Input Voltage		All	180	300	450	V _{dc}
Input Under Voltage Lockout						
Turn-On Voltage Threshold	Full load	All	165	170	175	V _{dc}
Turn-Off Voltage Threshold	Full load	All	155	160	165	V _{dc}
Lockout Hysteresis Voltage	Full load	All		10		V _{dc}
Maximum Input Current	V _{in} =180V, Full load	3V3Vo		347		mA
		05Vo		520		
		Others		477		
No-Load Input Current	V _{in} =300V, I _o =0A	See Model Number Table				mA

OUTPUT CHARACTERISTICS

PARAMETER	NOTES and CONDITIONS	Device	Min.	Typ.	Max.	Units
Voltage Set Point Accuracy	V _{in} =300V, Full load, T _c =25°C	All	-1.0		+1.0	%
Output Voltage Regulation						
Load Regulation	Full load to no load	3V3Vo			±0.3	%
		05Vo			±0.2	
		Others			±0.2	
Line Regulation	V _{in} =High line to low line, full load	All			±0.2	%
Temperature Coefficient	T _c =-40°C to 100°C	All			±0.02	%/°C
Output Voltage Ripple and Noise (5Hz to 20MHz Bandwidth)						
Peak-to-Peak	Full load, 1uF ceramic capacitors	3V3Vo			100	mV
		05Vo			120	
		12Vo			150	
		15Vo			150	
		24Vo			240	
		48Vo			480	
RMS.	Full load, 1uF ceramic capacitors	3V3Vo			60	mV
		05Vo			60	
		12Vo			60	
		15Vo			60	
		24Vo			100	
		48Vo			200	
Output Current Range	V _{in} = 180 to 450V	See Model Number Table				A
Over Current Protection	Hiccup mode. Auto recovery	All	110	135	160	%
Short Circuit Protection		All	Continuous, Auto Recovery			
External Load Capacitance	Full load (resistive)	See Model Number Table				uF



CQB75-300S CMFC(D) Series

PARAMETER	NOTES and CONDITIONS	Device	Min.	Typ.	Max.	Units
Output Voltage Trim Range	$P_o \leq \text{max. rated power, } I_o \leq I_{o_max}$	3V3Vo	-20		+10	%
		05Vo			+20	
Output Voltage Remote Sense Range	$P_o \leq \text{max. rated power, } I_o \leq I_{o_max}$ % of nominal V_o	3V3Vo			+10	%
		05Vo			+20	
Over Voltage Protection	Limited voltage, % of nominal V_o	3V3Vo	112		130	%
		05Vo			130	
		Others	122		130	

EFFICIENCY

PARAMETER	NOTES and CONDITIONS	Device	Min.	Typ.	Max.	Units
100% Load	$V_{in}=300V$	See Model Number Table				%

DYNAMIC CHARACTERISTICS

PARAMETER	NOTES and CONDITIONS	Device	Min.	Typ.	Max.	Units
Output Voltage Current Transient						
Error Band	75% to 100% of I_{o_max} step load change $dI/dt=0.1A/us$ (within 1% V_{out} nominal)	All			± 5	%
Recovery Time		All			250	us
Turn-On Delay and Rise Time						
Full load (constant resistive load)						
Turn-On Delay Time, From On/Off Control	$V_{on/off}$ to 10% V_{o_set} , Remote on	All		30		ms
Turn-On Delay Time, From Input	$V_{in_min.}$ to 10% V_{o_set} , Power up	All		30		ms
Output Voltage Rise Time	10% V_{o_set} to 90% V_{o_set}	All		30		ms

ISOLATION CHARACTERISTICS

PARAMETER	NOTES and CONDITIONS	Device	Min.	Typ.	Max.	Units
Isolation Voltage (100% factory Hi-Pot tested @2sec.)	1 Minute; input to output	All			3000	V_{ac}
					4200	V_{dc}
	1 Minute; input to case (base plate)				2500	V_{ac}
	1 Minute; output to case (base plate)				3500	V_{dc}
Isolation Resistance	Input to output	All	100			M Ω
Isolation Capacitance	Input to output	All		333		pF
		3V3Vo		2270		
		05Vo		2220		
	Input to case (base plate)	12Vo		1880		
		15Vo		1560		
		24Vo		2000		
		48Vo		2080		
Output to case (base plate)	All		18800			

FEATURE CHARACTERISTICS

PARAMETER	NOTES and CONDITIONS	Device	Min.	Typ.	Max.	Units
Switching Frequency	Pulse width modulation (PWM), fixed	All	270	300	330	KHz
On/Off Control, Positive Remote On/Off Logic, Refer to -Vin Pin.						
Logic Low (Module Off)	$V_{on/off}$ at $I_{on/off}=0.0uA$, Pin open=off	All	0		1.2	V
Logic High (Module On)	$V_{on/off}$ at $I_{on/off}=1.0mA$	All	3.5		12	V
On/Off Control, Negative Remote On/Off Logic, Refer to -Vin Pin						
Logic High (Module Off)	$V_{on/off}$ at $I_{on/off}=1.0mA$	All	3.5		12	V
Logic Low (Module On)	$V_{on/off}$ at $I_{on/off}=0.0uA$, Pin open=on	All	0		1.2	V



CQB75-300S CMFC(D) Series

PARAMETER	NOTES and CONDITIONS	Device	Min.	Typ.	Max.	Units
On/Off Current (for both remote on/off logic)	$I_{on/off}$ at $V_{on/off}=3.5-12V$	All	0.3		2.1	mA
Off Converter Input Current	Shutdown Input Idle Current	All		3	5	mA
Over Temperature Shutdown	Temperature at the center part of base plate, non-latching (DC Module)	All		110		°C
Over Temperature Recovery		All		100		°C

GENERAL SPECIFICATIONS

PARAMETER	NOTES and CONDITIONS	Device	Min.	Typ.	Max.	Units
MTBF	$I_o=100\%$ of I_{o_max} ; MIL-HDBK - 217F_Notice 1, GB, 25°C	3V3Vo		606		K hours
		05Vo		466		
		12Vo		566		
		15Vo		607		
		24Vo		700		
		48Vo		650		
Weight		-CMFC		197		grams
		-CMFD		225		
		-CMFD+HS		465		
		-CMFD+HD		483		
Base plate Material	Aluminum					
Potting Material	UL 94V-0 (DC Module)					
Shock/Vibration	MIL-STD-810F Compliant					
Humidity	95% RH max. Non Condensing					
Altitude	3000m Operating Altitude, 12000m Transport Altitude					
Thermal Shock	MIL-STD-810F					
Fire & Smoke	EN45545-2 Compliant					
EMI	EN55032 & EN55022 Compliant					Class A
ESD	EN61000-4-2 Level 3: Air $\pm 8kV$, Contact $\pm 6kV$					Perf. Criteria A
Radiated immunity	EN61000-4-3 Level 3: 80~1000MHz, 20V/m					Perf. Criteria A
Fast Transient	EN61000-4-4 Level 3: On power input port, $\pm 2kV$					Perf. Criteria A
Surge	EN61000-4-5 Level 4: Line to earth, $\pm 4kV$, Line to line, $\pm 2kV$					Perf. Criteria A
Conducted immunity	EN61000-4-6 Level 3: 0.15~80MHz, 10V					Perf. Criteria A
Power Frequency Magnetic Field immunity	EN61000-4-8 50/60Hz, 3A/m (r.m.s.)					Perf. Criteria A
Application Note Link	CQB75-300S CMFC(D) Series App Notes					
Packaging Information Link	Packaging Information					



CQB75-300S CMFC(D) Series

Immunity to Environmental Conditions.

Phenomenon	Reference Clause(s)	Reference Standard	Test Conditions	Result
Vibration Test	MIL-STD-810F Table 514.5C-VIII Figure 514.5C-6	MIL-STD-810F	Unit are non-operating Vibration Waveform: Random Vibration Frequency: 15 ~ 2000 Hz Vibration axis: X \ Y \ Z axis Duration: 1hr/axis	Vibration Test
Shock Test	MIL-STD-810F 516.5 Table 516.5-I	MIL-STD-810F	Wave form: Sawtooth wave Test Category: Crash Hazard Test for Ground Equipment Duration: 10 ms Peak Acceleration: 75 G Cross-over Frequency: 80 Hz No. of Shock: Each axis 3 times Shock Direction: $\pm X$, $\pm Y$, $\pm Z$ axis	Shock Test
Thermal Shock Cycling Test	MIL-STD-810F 503.4 Figure 503.4-1	MIL-STD-810F	Temperature : -55°C to 105°C Humidity: 95%RH Duration: 8hrs/ 3 times cycling & 4hrs dwell time	Thermal Shock Cycling Test
Thermal Humidity Cycling Test	MIL-STD-810F Notice 3 Method 507.4	MIL-STD-810F	Temperature: 60°C to 30°C Humidity: 95%RH Duration: 240 hrs	Thermal Humidity Cycling Test

EN45545-2 Fire & Smoke Test Conditions.

Item		Standard	Hazard Level
R22	Oxygen Index Test	EN 45545-2: 2013 EN ISO 4589-2: 2006	HL1, HL2, HL3
	Smoke Density Test	EN 45545-2: 2013 EN ISO 5659-2: 2013	HL1, HL2, HL3
	Smoke Toxicity Test	EN 45545-2: 2013 NF X70-100: 2006	HL1, HL2, HL3
R23	Oxygen Index Test	EN 45545-2: 2013 EN ISO 4589-2: 2006	HL1, HL2, HL3
	Smoke Density Test	EN 45545-2: 2013 EN ISO 5659-2: 2013	HL1, HL2, HL3
	Smoke Toxicity Test	EN 45545-2: 2013 NF X70-100: 2006	HL1, HL2, HL3
R24	Oxygen Index Test	EN45545-2: 2013 EN ISO 4589-2	HL1, HL2, HL3
R25	Glow - Wire Test	EN 45545-2:2013 EN 60695-2-11:2001	HL1, HL2, HL3
R26	Vertical Flame Test	EN 45545-2: 2013 EN 60695-11-10: 2013	HL1, HL2, HL3



CQB75-300S CMFC(D) Series

CHARACTERISTIC CURVE

Power Derating Curve

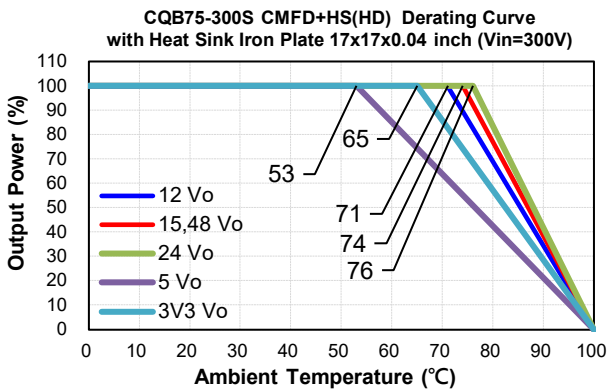
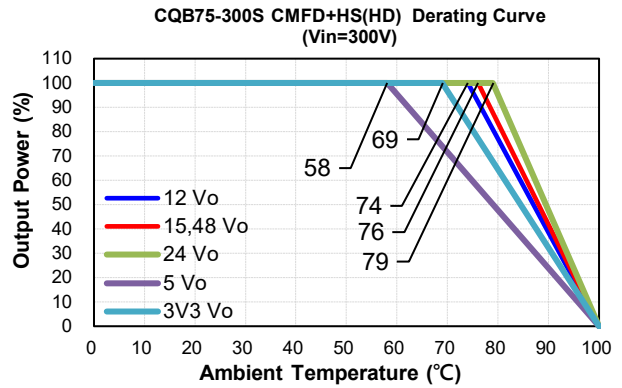
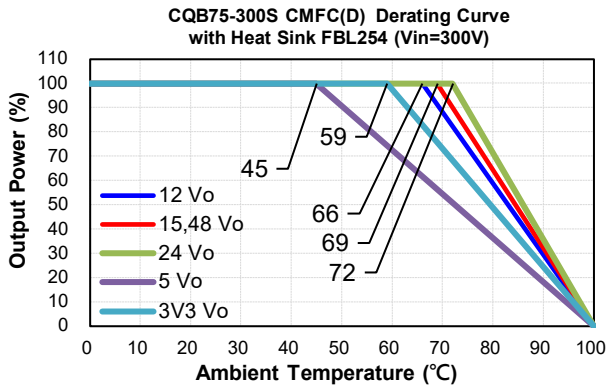

Performance Data

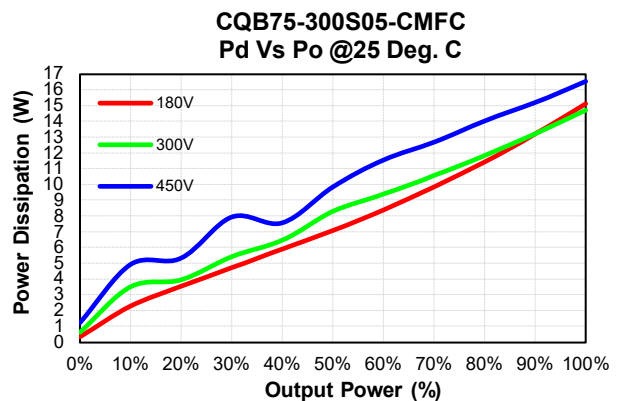
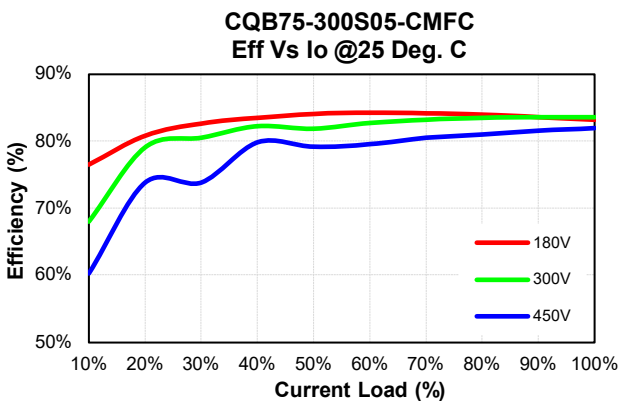
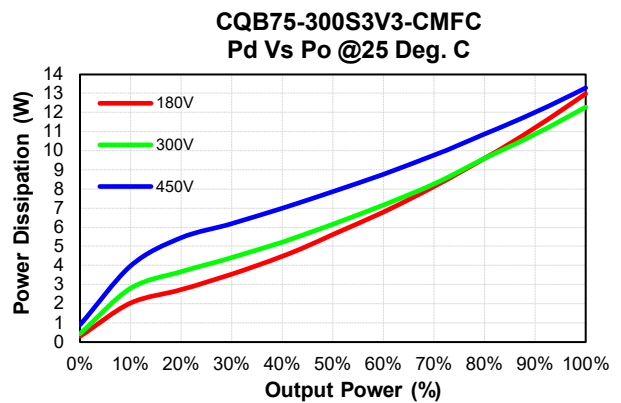
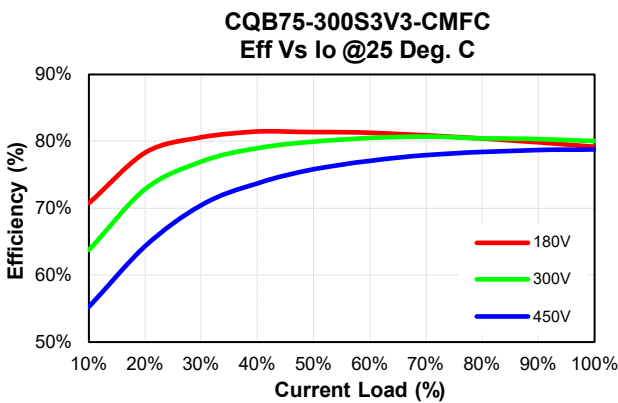



CQB75-300S CMFC(D) Series

CQB75-300S12-CMFC
Eff Vs Io @25 Deg. C

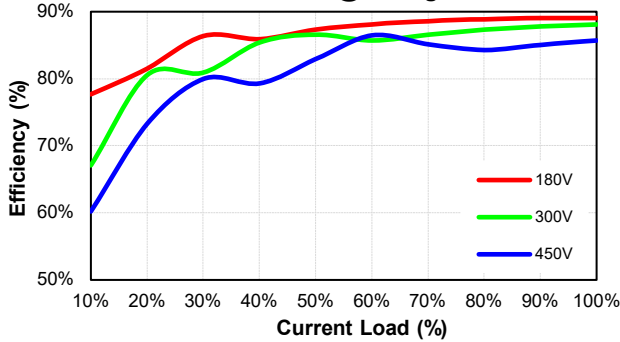

CQB75-300S12-CMFC
Pd Vs Po @25 Deg. C

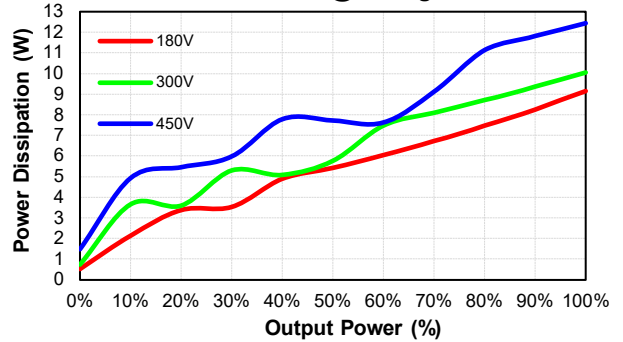

CQB75-300S15-CMFC
Eff Vs Io @25 Deg. C

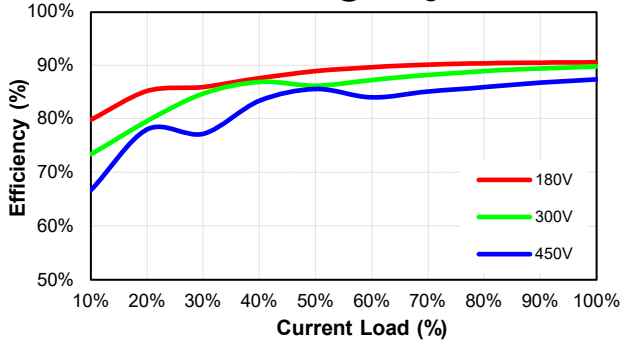

CQB75-300S15-CMFC
Pd Vs Po @25 Deg. C

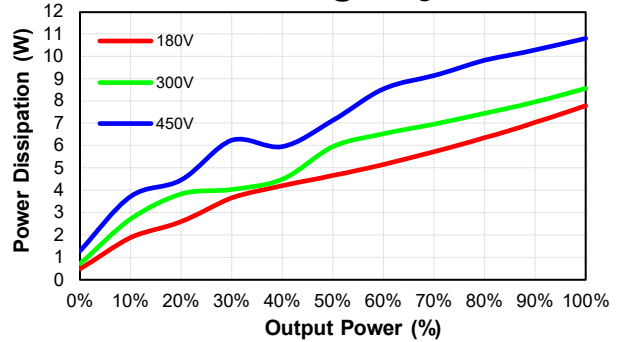

CQB75-300S24-CMFC
Eff Vs Io @25 Deg. C

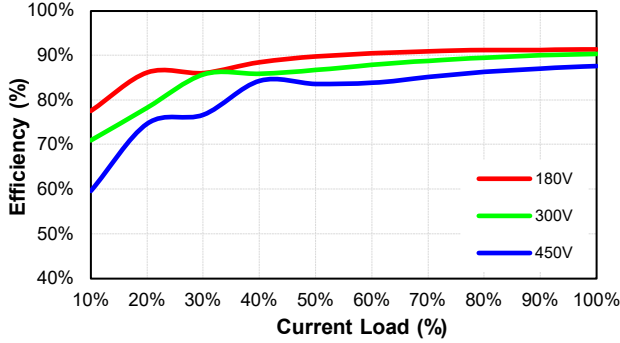

CQB75-300S24-CMFC
Pd Vs Po @25 Deg. C

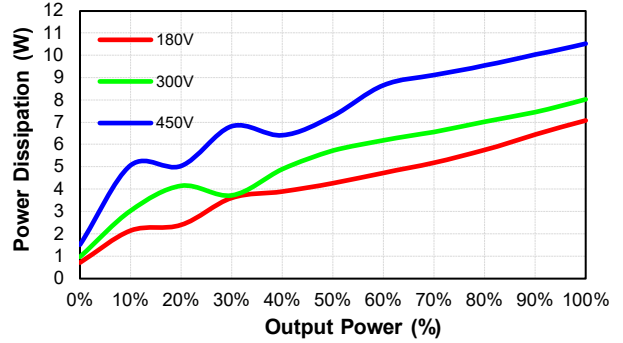

CQB75-300S48-CMFC
Eff Vs Io @25 Deg. C

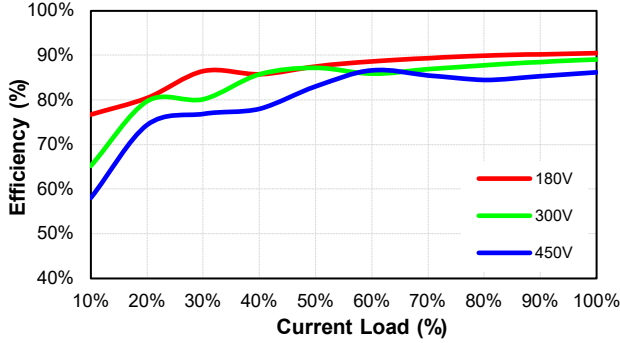

CQB75-300S48-CMFC
Pd Vs Po @25 Deg. C

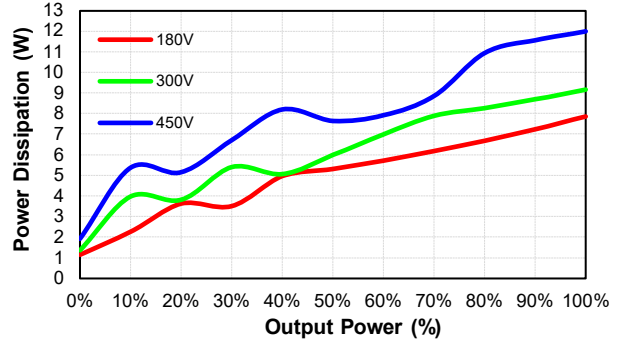



CQB75-300S CMFC(D) Series

MECHANICAL SPECIFICATION

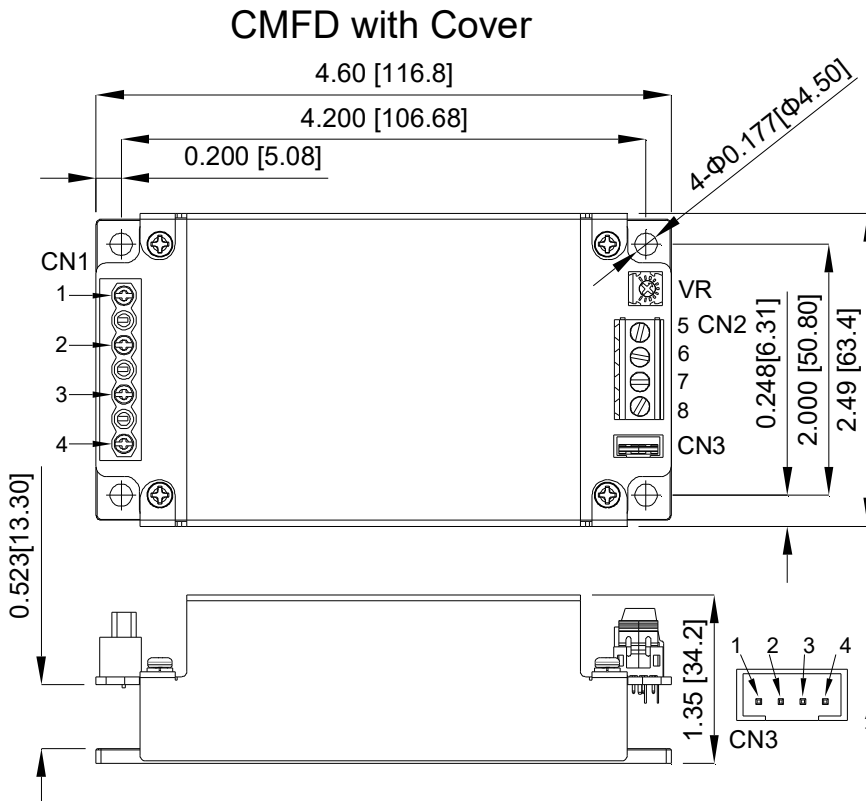
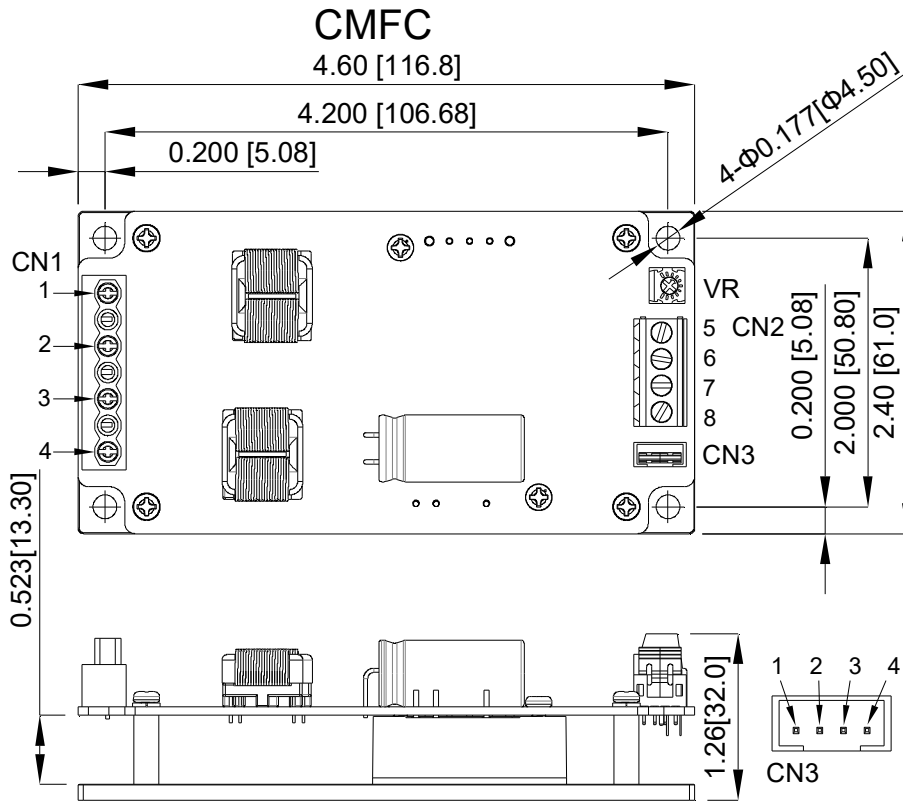

CN1 & CN2 PIN CONNECTION

PIN	Function
1	+V Input
2	-V Input
3	Remote
4	Case
5	+V Output
6	+V Output
7	-V Output
8	-V Output

CN3 PIN CONNECTION

PIN	Function
1	-V Output
2	-Sense
3	+Sense
4	+V Output

All Dimensions in Inches[mm]
Tolerance Inches: x.xx=±0.02, x.xxx=±0.010
Millimeters: x.x=±0.5, x.xx=±0.25



CQB75-300S CMFC(D) Series

MECHANICAL SPECIFICATION

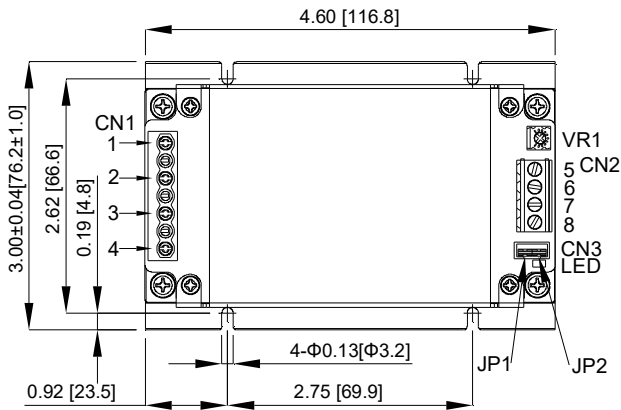

CMFD+HS

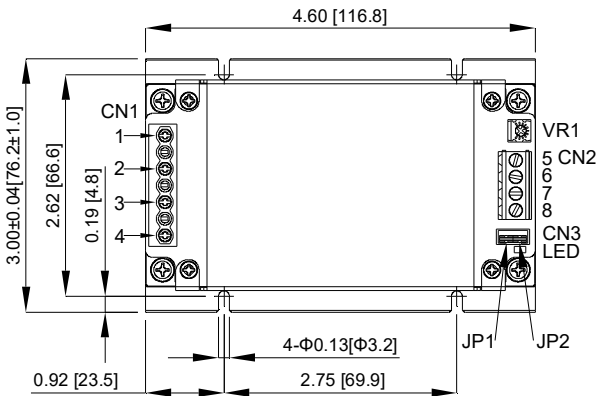
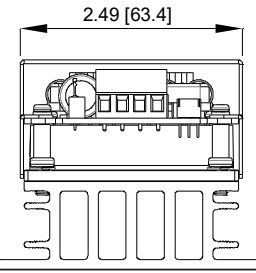
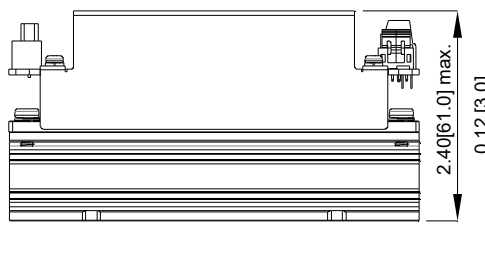
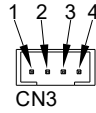

CMFD+HD

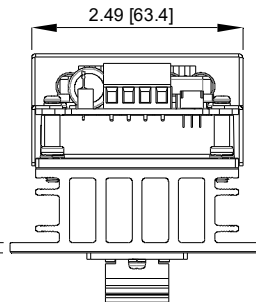
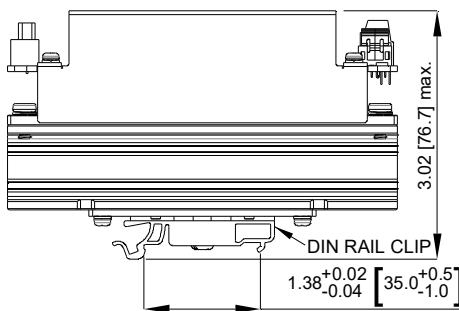
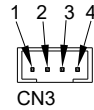

CN1 & CN2 PIN CONNECTION

PIN	Function
1	+V Input
2	-V Input
3	Remote
4	Case
5	+V Output
6	+V Output
7	-V Output
8	-V Output

CN3 PIN CONNECTION

PIN	Function
1	-V Output
2	-Sense
3	+Sense
4	+V Output

*JP1: Short PIN1 & PIN2
*JP2: Short PIN3 & PIN4

All Dimensions in Inches[mm]
Tolerance Inches: x.xx=±0.02, x.xxx=±0.010
Millimeters: x.x=±0.5, x.xx=±0.25